

PROMET

## SAFE DIGITAL LOCK

## PS610/E36

## USER MANUAL

## 1 Main Components

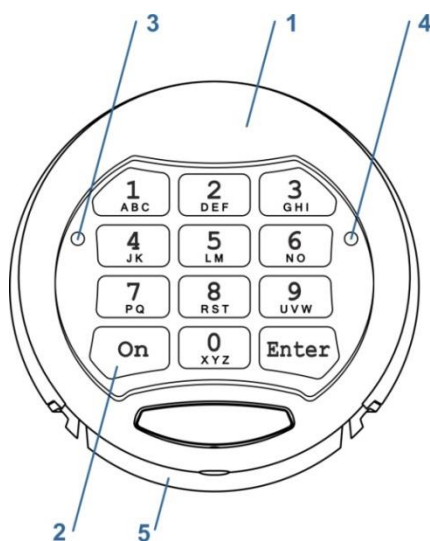

Fig.1.1

1 – Case, 2 – Keypad, 3 – Green LED [G], 4 – Red LED [R], 5 – Battery box

## 2 Definitions

## 2.1 Master Code [PIN1]

A set of numbers (from 6 to 8 digits) which opens the lock and allows to operate the settings.

**!** Before using the safe, please change the factory Master code (see par.4.1). It is strongly recommended to keep the master code safe from unauthorized people.

No easily guessed numbers (birthdays, house and phone numbers, etc.) or simple codes (1, 2, 3, 4, 5, 6) shall be chosen for the code.



Factory Master Code:  
1-2-3-4-5-6

## 2.2 User Code [PIN2]

A set of numbers from 6 to 8 digits which opens the lock and has limited functions to change the settings.



The lock with default factory settings does not have the User code. Please see par.4.2 to set the User code.

## 2.3 Signals

[G]<sup>1</sup> Short single acoustic signal with single green LED flash (3) – confirmation of the button pressing on the keypad.

[G]<sup>2</sup> Short double acoustic signal with double green LED flash (3) – confirmation of successfully finished operation.

[R]<sup>--</sup> Long single acoustic signal with single red LED flash (4) – error message on the user's actions.

[R]<sup>5</sup> Short acoustic signal sounds 5 times with 5 red LED flashes (4) – low battery message. Please see par.7.1 how to change the battery.

## 3 Main Functions

## 3.1 Opening the Lock

3.1.1 Opening with the Factory Master code  
[ON] [1] [2] [3] [4] [5] [6] [Enter]

3.1.2 Opening with the Master Code  
[ON] [PIN1] [Enter]

3.1.3 Opening with the User Code  
[ON] [PIN2] [Enter]

If the code is right, there will be a green LED flash and it will be possible to open the door within 5 seconds by turning the door hand clockwise.



If you enter a wrong code three times in a row, the lock will be blocked for 5 minutes. This will be indicated via periodical red LED flashes.

## 3.2 Closing the Lock

Close the door and turn the door hand anti-clockwise until it stops.

## 4 Service Functions



It is strongly recommended to change the settings of the lock with the door opened. After code changing, the lock shall be tested several times with the secure storage unit's door in open state.



The service functions will be unavailable in case of low power supply which is indicated by the signals, please refer to par.2.3, [R]<sup>5</sup>.

## 4.1 Changing the Master Code [PIN1]

[ON] [Enter] [1] [Enter] [PIN1] [Enter]  
[new PIN1] [Enter] [repeat new PIN1] [Enter]

Checking the new Master code:

[ON] [new PIN1] [Enter]

## 4.2 Setting and changing the User Code [PIN2] with the Master Code [PIN1]



Before changing the User Code [PIN2] default factory setting of Master code [PIN1] has to be changed (see par.4.1).

[ON] [Enter] [2] [Enter]  
[1-9 (user number)] [Enter] [PIN1] [Enter]  
[new PIN2] [Enter]  
[repeat new PIN2] [Enter]

Checking the new User code:

[ON] [new PIN2] [Enter]

#### 4.3 Changing the User Code [PIN2] without the Master Code

[ON] [Enter] [3] [Enter]  
 [1-9 (user number)] [Enter] [PIN2] [Enter]  
 [new PIN2] [Enter]  
 [repeat new PIN2] [Enter]

Checking the new User Code:

[ON] [new PIN2] [Enter]

#### 4.4 Deleting the User Code

[ON] [Enter] [0] [Enter] [1-9 (user number)]  
 [Enter] [PIN1] [Enter]

#### 4.5 Switching off/switching on the sound

[ON] [Enter] [5] [Enter] [PIN1] [Enter]

### 5 Time Delay Function

#### 5.1 Switching on the Time Delay function

[ON] [Enter] [6] [Enter] [PIN1] [Enter]  
 [01-99 - delay time] [1-9 - time for opening] [Enter]

 E.g.: 092 – 9 minutes is the delay time, 2 minutes is the time for opening

#### 5.2 Opening the Lock with the Time Delay

[ON] [PIN1 or PIN2] [Enter] (Waiting Delay Time. Acoustic signal will inform about the end.) [PIN1 or PIN2] [Enter]

 Pressing [Enter] during Time Delay leads to an interruption. Operation has to be started again.

#### 5.3 Switching off the Time Delay function

[ON] [Enter] [6] [Enter] [PIN1] [Enter]  
 [000] [Enter]

### 6 Dual Code Function

#### 6.1 Switching on the Dual Code function

 Before switching on the function, make sure you have assigned a User Code [PIN2] see par.4.2.

 The Dual Code function has priority over other lock functions.

[ON] [Enter] [7] [Enter] [PIN1] [Enter]

 When press [ON] button, switched on Dual Code function indicates [ $\blacktriangleleft$ G]<sup>2</sup> (see par.2.3).

#### 6.2 Opening with the Dual Code function

[ON] [0-9 (user number)] [Enter]  
 [PIN2] [Enter]  
 [0-9 (user number)] [Enter]  
 [PIN3] [Enter] – in 1 minute

 The User number of Master Code is [0].

 After right first Code was entering [PIN2][Enter], for enter the second Code [PIN3][Enter] there are just 1 minute, that indicates [ $\blacktriangleleft$ G]<sup>1</sup> (see par.2.3) every 5 seconds.

#### 6.3 Switching off the Dual Code function

[ON] [Enter] [8] [Enter] [PIN1] [Enter]

### 7 Servicing

#### 7.1 Changing the Battery

- The pullout battery box (5) is located on the inner side of the case (1).
- Remove the screw blocking the battery box (see Fig.7.1).
- Squeeze latches and pull the battery box down (see Fig.7.1).

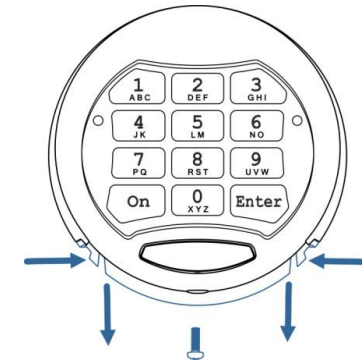

Fig. 7.1

- Disconnect the battery from the contact pads, placed to the right, as shown in Fig.7.2.

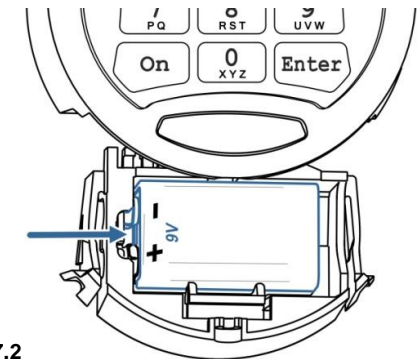

Fig. 7.2

- Remove the battery and replace it with a new one (9V, type 6LF22).
- Take the box and screw it back in the reverse order to their location.